

## FIST-GCO2

### GCO2-BC6/16-XX GCO2-BD6/16-XX GCO2-BE6/16-XX

<b>Content</b>	<b>1 Introduction</b>  <b>2 General</b> 2.1 Abbreviation 2.2 Kit Contents 2.3 Elements needed from the FIST installation kit 2.4 Tools 2.5 Cable preparation table  <b>3 Installation</b> 3.1 Installation of workstand 3.2 Opening the FIST GCO2  <b>4 Cable preparation</b> <b>4.1 Loose buffer tube cable</b> 4.1a Looped cable preparation 4.1b Bracket/strength member 4.1c Loose buffer tube storage 4.1d Fiber storage in trays 4.1e Drop cable preparation (6 port base) 4.1f Drop cable preparation (16 port base) single fiber, ribbon and compact sheet cable 4.1g Tube preparation	<b>4.2 Central core cable</b> 4.2a Looped cable preparation 4.2b Bracket/strength member 4.2c Mass storage facility and twisted fibers:(Using Basket) 4.2d Twistfree fibers 4.2e Drop cable preparation (6 port base) 4.2f Drop cable preparation (16 port base)  <b>5 Heatshrink installation</b>  <b>6 Fiber routing</b>  <b>7 Fiber routing on tray</b>  <b>8 Tube holder capacity</b>  <b>9 Cable grounding</b>  <b>10 Closing the closure</b>  <b>11 Important steps</b>  <b>12 Re-arrangement</b>
----------------	---	---

## 1 Introduction

The generic closure FIST-GCO2 is the environmentally sealed enclosure for the fiber management system that provides the functions of splicing and passive component integration in the external network. The product can be tailored to almost any required configuration by adding splicing and/or passive device Sub-Assemblies. The FIST-GCO2 has provision for all cable termination and sealing requirements.

To clean FIST components, the use of isopropylalcohol is recommended.

The closure is a single-ended design made of a thermoplastic material.

The base and dome are sealed with a clamp and an O-ring system. One oval entry port for looped (uncut) cable management and six or sixteen round ports for single cable entry/exit are included in the base. The cable seals are manufactured from heat-shrinkable material. The Universal Mounting System provides the foundation for mounting SOSAs and SASAs back to back. The two back to back sides have each a standard capacity of 28, 42 or 58 units. Uncut loose buffer tube storage is available between the two UMS-sides (Universal Mounting System). Storage of uncut looped ribbons or fibers from central core (or slotted core) cables is available with the fiber storage basket. Storage of uncut looped ribbons or fibers can be done in individual FIST-trays.

## Dimensions (in mm)

Closure Type	GCO2-BC6-XX	GCO2-BD6-XX	GCO2-BE6-XX
L	488	566	700
D with clamp	285	285	285

Closure Type	GCO2-BC6-XX	GCO2-BD6-XX	GCO2-BE6-XX
Capacity			
Primary coated fibers			
Single element	336	480	672*
Single circuit 2	112	160	224
Single circuit 4	224	320	448
Ribbon 4			
2 ribbons each tray	40 (160 fibercount)	80 (320)	110 (440)
1 ribbon each tray	20 (80 fibercount)	40 (320)	55 (220)
Ribbon 12			
1 ribbon each tray	16 (192 fibercount)	28 (336)	36 (432)

\* Capacity on FAS can depend on capacity on tubeholder, see for instance the capacity table for loose tubes later on

## Cable diameters in 6 port base

Loose tube	loop, 12-25 mm	drop,(5-30 mm)
C.Core	loop, 12-25 mm	drop,(5-30 mm)

## Cable diameters in 16 port base

Loose tube	loop, 12-25 mm	drop ports 3-10, (5-20 mm)	drop ports 11-18, (5-14 mm)
C.Core	loop, 12-25 mm	drop ports 3-10, (5-20 mm)	drop ports 11-18, (5-14 mm)

## 2 General

### 2.1 Abbreviations

Looped Cable Installation Tool	LCIT
Universal Mounting System	UMS

### 2.2 Kit contents



Depending on network layout and cable construction, kit contents received by the customer may differ from the kit contents described in this installation instruction.

- Dome
- Base including routing block + cover (universal mounting system), shield mounting bolt, and strength member termination bracket
- Clamp
- O-ring
- 2 tray covers + fiber guiding pin +tube holder retainers
- 2 tray wedges

Image for reference only.

## 2.3 Elements possibly needed from the FIST installation kit

Product Name	UOM	QTY/UOM	Product description
FISTV-E7185-3010	1 RL	50 m	Cut wire to open the FIST-GCO2 ports
E7100-0075(B10)	1 PK	10x75g	Silicagel for inside the closure, to be replaced after each re-entry
FISTV-SPLI-COL	1 PK	30 sets	Split identifications collet (2-sizes) till 3.5 mm

## 2.4 Tools

• FIST-LCIT	Looped tube insertion tool for oval outlet	To insert loose tubes in oval port
• FACC-TUBE-CUTTER-01	Tube cutter	To cut spiral tubing
• FACC-TUBE-STRIPPER-02	Tube stripper	To strip loose tubes
• FACC-AXIAL-STRIPPER-RC1	Tube splitter	To split buffer tubes 2.0-3.1mm
• FACC-HEAT-GUN-220V	Heatgun + Heatgun tip	To shrink cable seals
• FIST-WORK-STAND		To hold the closure in a vertical position during installation
• FIST-WORK-STAND-H	Hinging workstand	To hold the closure (6 ports) in any position during installation
• FIST-WORK-STAND-16-H	Hinging workstand	To hold the closure (16 ports) in any position during installation

## 2.5 Cable preparation table

		Window cut	drop cable
Loose Tube	BC6 or 16	3.5 m	2.2 m
	BD6 or 16	3.7 m	2.2 m
	BE6 or 16	3.9 m	2.2 m
Twisted C.Core (Use Basket)	BC6 or 16	5.3 m	2.2 m
	BD6 or 16	5.9 m	2.2 m
	BE6 or 16	6.1 m	2.2 m
Untwisted C.Core	BC6 or 16	3.5 m	2.2 m
	BD6 or 16	3.7 m	2.2 m
	BE6 or 16	3.9 m	2.2m

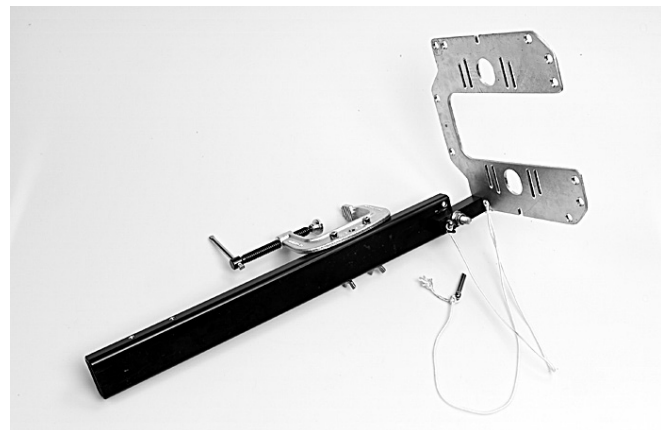

## 3 Installation

### 3.1 Installation of workstand

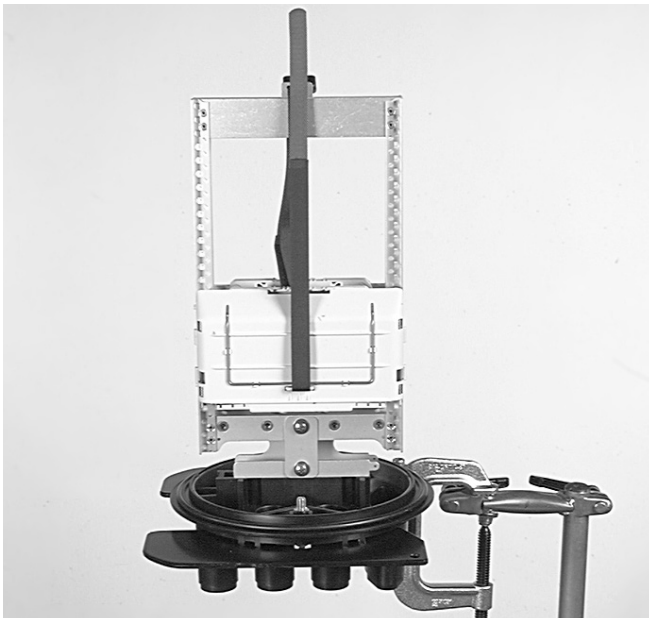

3.1.1 The FIST-GCO2 will be mounted temporary on the work-stand. The work-stand is wrap-around, so that the FIST-GCO2 installed with cables can be taken away from it. Secure the FIST-GCO2 base onto the workstand with the four split-pen.

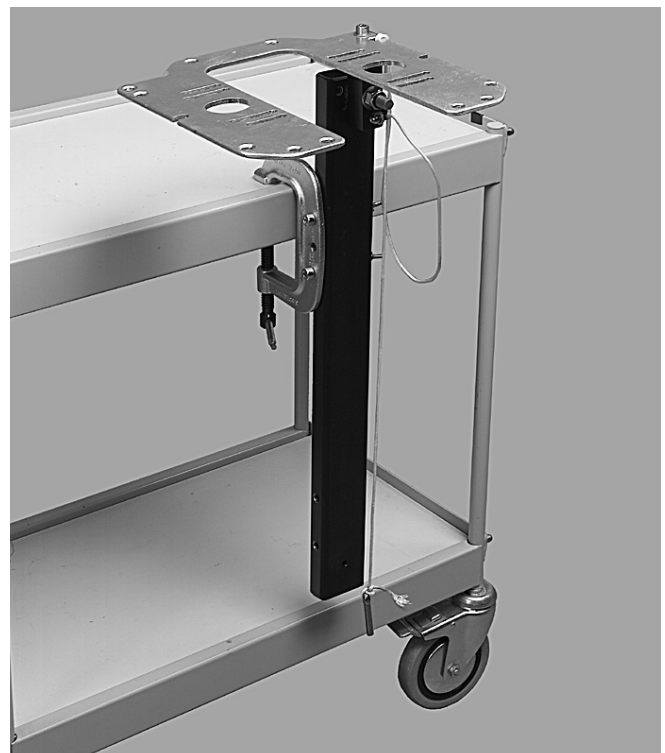

3.1.2 The hinging work stand can be used. It is recommended when the 16 port base is applied.

### 3.2 Opening the FIST-GCO2

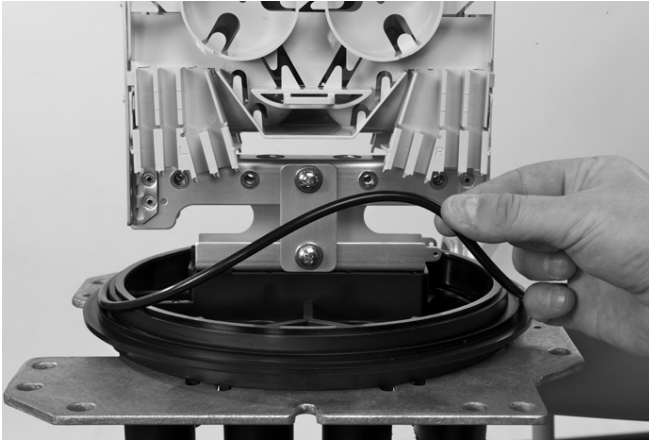

3.2.1 Open and remove the clamp. Remove the dome and the O-ring  
Remark: be careful with the O-ring and the sealing surfaces on the base and dome (avoid damaging). Clean only with clear water or with the cleaning tissue, included in the kit, if needed

## 4 Single fiber

### 4.1 Loose buffer tube cable

#### 4.1a Looped cable preparation

4.1.1 Scafe: A window cut of 3m50 is needed for GCO2-BC6-XX, 3m70 for GCO2-BD6-XX and 3m90 for GCO2-BE6-XX.

4.1.2 Scafe: mark the cable in the middle and mark the cable (1.75), (1.85) or (1.95) meters left and right of the first mark. Remove the cable jacket starting in the middle.

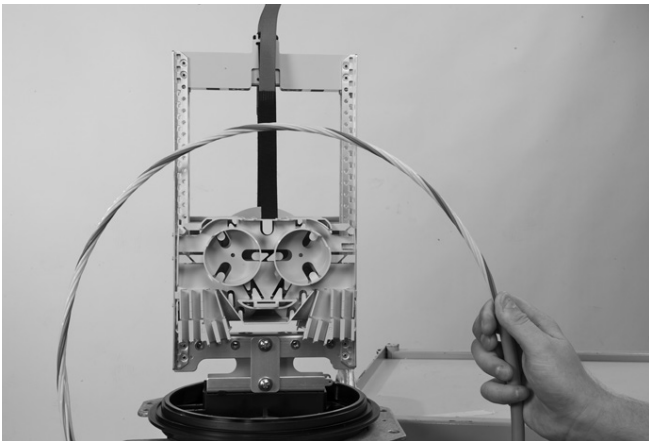

4.1.3 Reversed Oscillating cable: mark the cable in the middle of the loop and remove the cable jacket left and right of the mark over a total distance of 110cm (little more as the distance between two reversal points). Locate the buffer tube reversal point on the cable and mark the cable (1.75), (1.85) or (1.95) meters left and right from this point. Remove the remaining cable jacket starting from this point.

**Important:** make sure that the twist position of loose tube is identical in A and B. **This must be done correctly for ease of installation.**

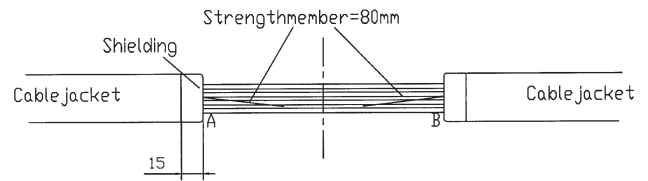
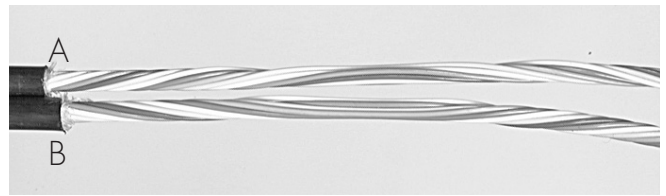

4.1.4 Remove the strength member leaving 80 mm from the cable jacket, if shield present leave 15mm of the shield

4.1.5 Clean the loose tubes, remove all grease.

4.1.6 Identify the loose tubes with the split collet rings markers if necessary. There are different FIST-split-collet-rings depending on diameter of the loose tube.

#### 4.1b Bracket/ Strength member and cable termination preparation

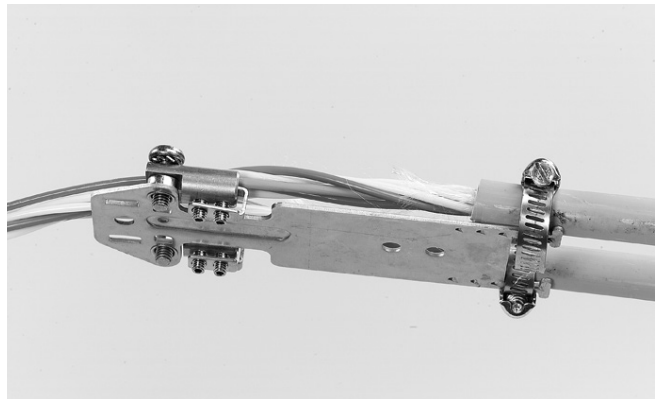

4.1.7 Insert the strength members of the cable into the universal strength member connector on the loop bracket (loosen the bolts with the Allen key if necessary) such that all loose tubes can be routed without unnecessary crossings. Avoid to twist the loop in the case of a reversed oscillating cable. Secure with the Allen key.

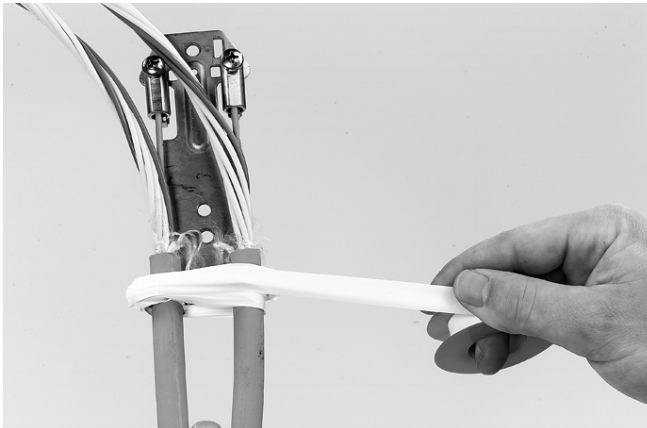
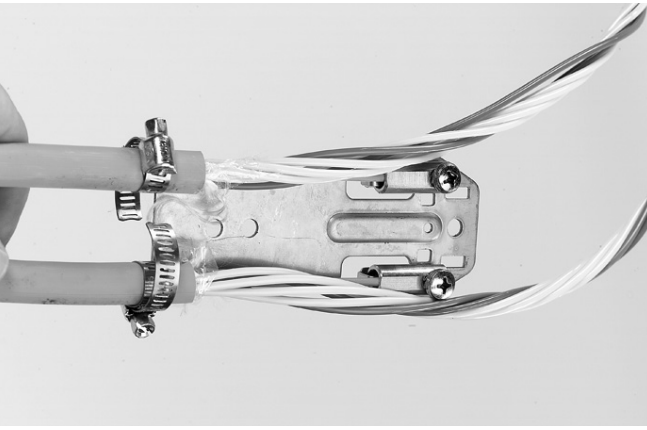

4.1.8 If the cable diameter is more than 8 mm Secure the cables with the hose clamp onto the loop bracket. Wrap a few layers of tape around the hose clamp. If the cable diameter is less than 8 mm secure the cables with tie wraps.

- When using cables with a diameter smaller than 12 mm, bend the sharp edges on the bottom of the bracket towards the cable.

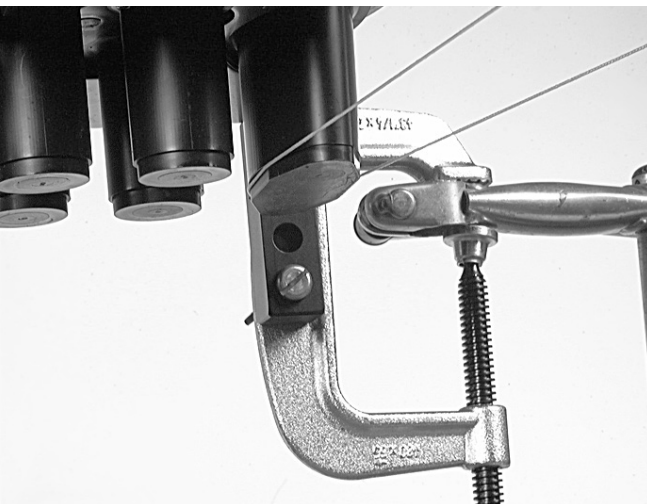

4.1.9 Open the oval port; the cutting wire can be used.



4.1.10 Take the oval sleeve and place the packing bag that has been opened on both sides in the oval sleeve to protect the hotmelt inside the sleeve against dirt and grease. Take the LCIT and bend the loose tubes gently over it. Push the loose tubes in the sleeve. The non-coated edge of the sleeve (arrow) should be pointed to the base of the closure.

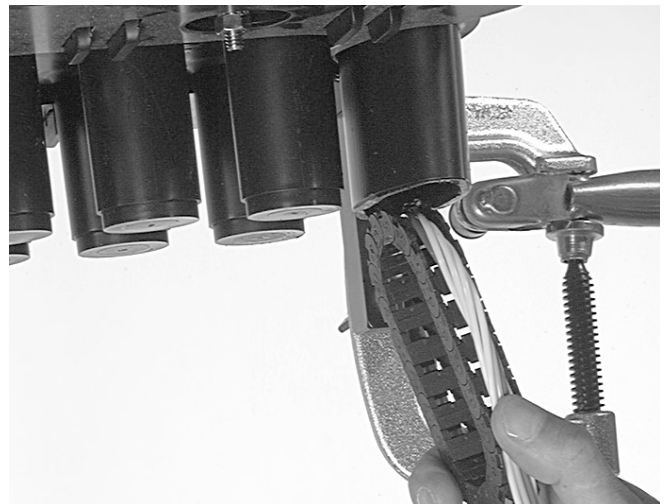

4.1.11 Push the loose tubes (looped around the LCIT) through the oval port. Remove the LCIT and pull the cable gently in the closure.

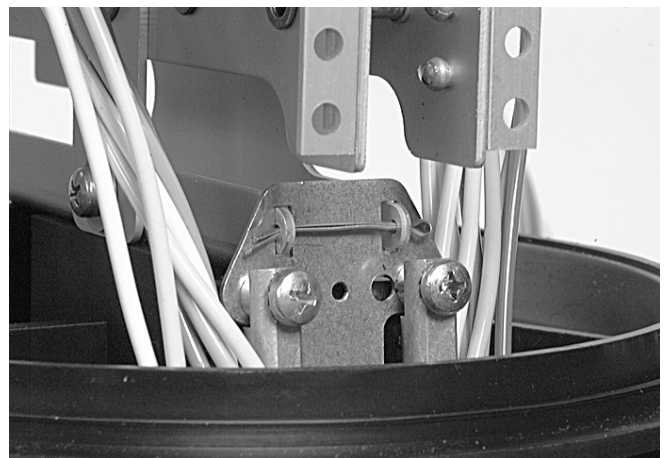

4.1.12 Position the loop bracket in the bottom bracket and lock with the split pin.

#### 4.1c Loose buffer tube storage

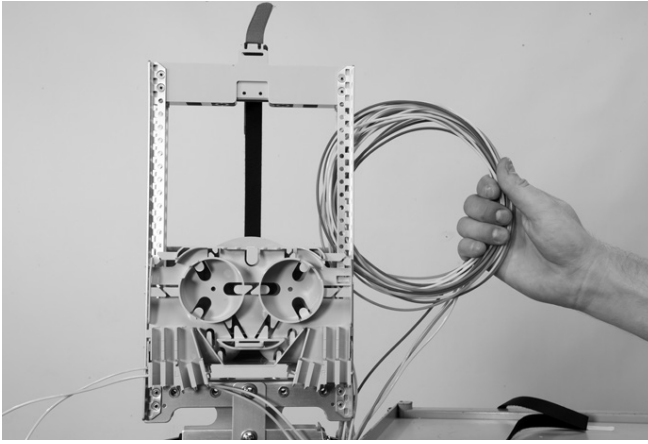

4.1.14 Make some loops with the uncut loose tubes, and put these in the plastic bag (Be careful not to damage the loose tubes!). Two sizes of bags are available. Use the correct size according to the volume of the loose tubes.

Slide the bag between the UMS. If the capacity of the looped loose tubes is too much, put the loops at one side; in this case secure the plastic bag with the tubes on the UMS-profiles with tie-wraps.

**Remark: loose tubes routed up to the tube holder should be routed in such a way that one still has complete access of the stored tubes between UMS profile. This is needed for later routing of loose tubes from the loops to the tube holders, without creating crossings and without creating disturbances on the loose tubes already routed up to the tube holders.**

#### 4.1d Fiber storage in trays

4.1.15 Select the loose tube(s) with the fibers that have to be spliced.

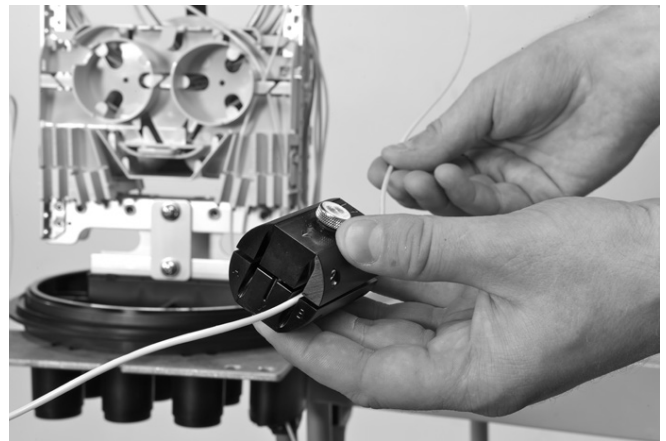
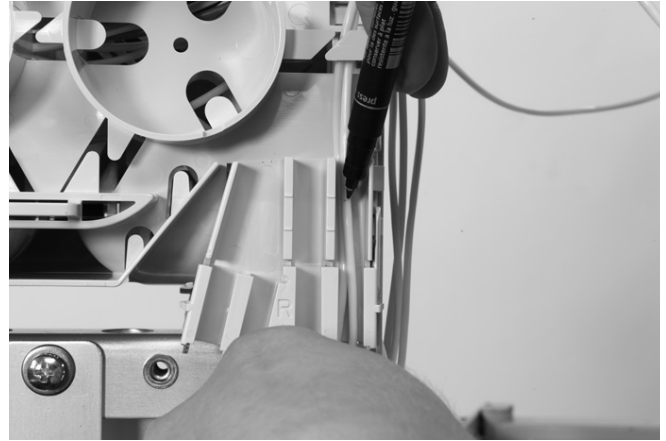

4.1.16 **In case of reversed oscillating cable (SZ-cable):** separate the loose tube(s). Match the loose tube(s) on the tubeholder and mark both sides between the two marks. Shave between the two marks with the appropriate tooling. Clean the fibers and wind some PTFE tape around the ends of the tubes and fibers, to protect the transition from tube to fibers.

**In case of S-cable:** cut the loose tube(s) (with fibers that have to be spliced) in the middle of the loop. Separate the cut loose tube(s) from the others. Match the loose tube(s) on the tubeholder and mark both sides. Strip the loose tube(s). Clean the fibers.

- Separate the fibers till the tubeholder and route to single circuit or single element tray(s).

1 Position the tube on the lowest tubeholder retainer. Slide a tubeholder until it snap above the tube.

2 Remove the lowest tubeholder retainer. Use a tweezer if necessary.

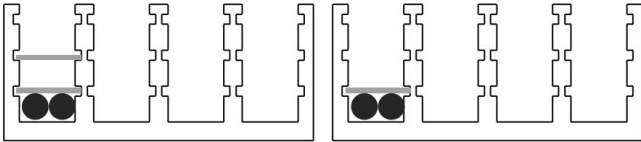
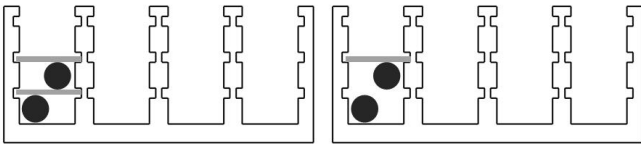

3 Slide this tubeholder retainer in the lowest possible groove, above the (two or more) tubes.

4 Remove the top tubeholder.

4.1.17 Different loops can be put together beneath the same tube holder retainer. Position one or more loose tubes in the tubeholder and slide the tube holder retainer with the snap forward in the lowest possible cavities of the tubeholder above the loose tube(s). The tube holder retainer must snap.



4.1.18 In case of **Reversed oscillating cable** Identify exchange and customer-side using some PTFE tape around the fibers. One can also use the FIST-split-collets-rings markers to identify the loose tubes.

4.1.19 - If the fibers are 'twist free' one can route the fibers separate to single circuit trays or single element trays. Separate all fiber loops first till the tubeholder.

If the fibers are not 'twist free' select first the fiber(s) that have to be spliced and cut these fibers in the middle of the loop. Remove these out of the bundle till the tubeholder. These fibers can be routed to single circuit trays, others uncut will be routed to a single element tray (never in dark fiber storage) (See at fiber routing).

#### 4.1e Drop cable preparation (6 port base)

4.1.20 Open the round port; the cutting wire can be used

4.1.21 Remove the cable jacket for 2.2m.

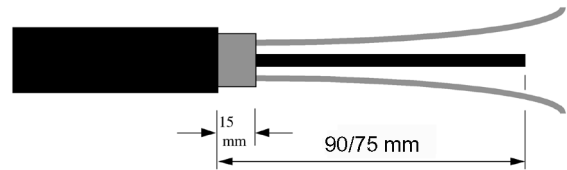

4.1.22 Remove the strength member leaving 90 mm from the cable jacket, if shield present leave 15 mm of the shield.

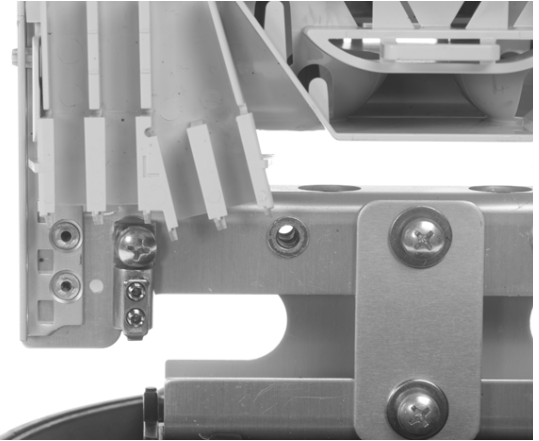

4.1.23 Secure the strength member connector in the closure (on the bottom bracket )

4.1.24 Take the sleeve and place the packing bag that has been opened on both sides in the sleeve to protect the hot melt inside the sleeve against dirt and grease. Push the loose tubes in the sleeves. The non-coated edge of the sleeve (arrow) should be pointed to the base of the closure (see installation heatshrink).

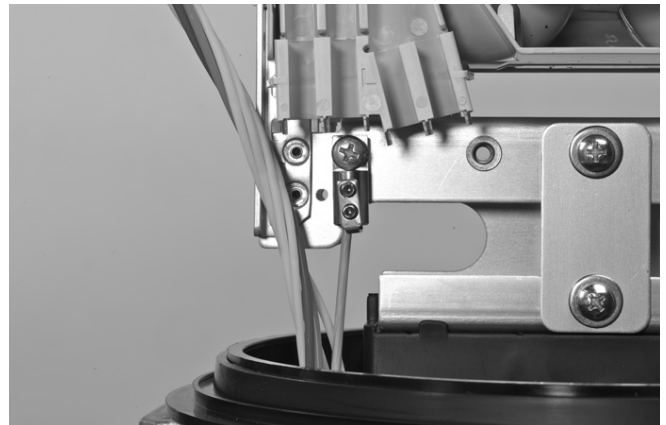

4.1.25 Push the loose tubes in the port and secure the strength member in the strength member connector. Be sure that all loose tubes are routed without crossing around the strength member.

#### 4.1f Drop cable preparation (16 port base)

4.1.26 Remove the cable jacket for 2.2m.

#### 4.1f Drop cable preparation (16 port base)

4.1.26 Remove the cable jacket for 2.2m.

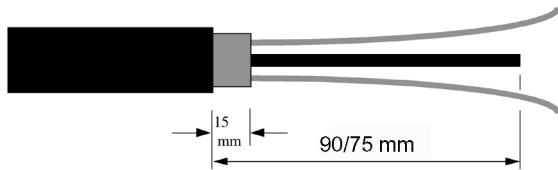

4.1.27 If big ports 3-4-5-6-7-8-9-10 are used, cut strength member at 90 mm length. If small ports 11-12-13-14-15-16-17 and 18 are used, cut strength member at 75 mm length.

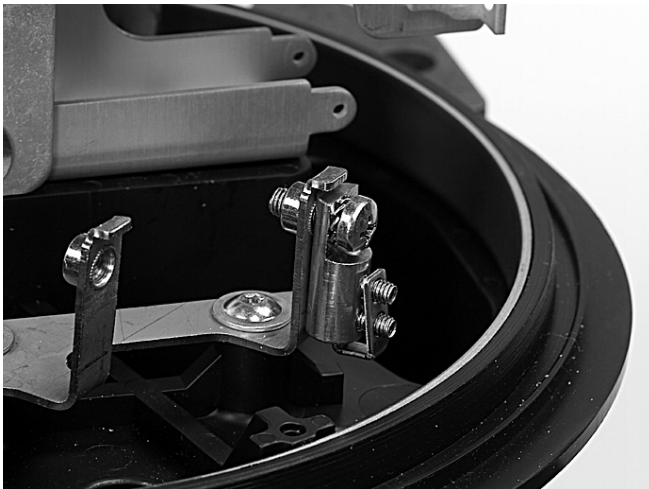

4.1.28 Secure the strength member connector in the closure.

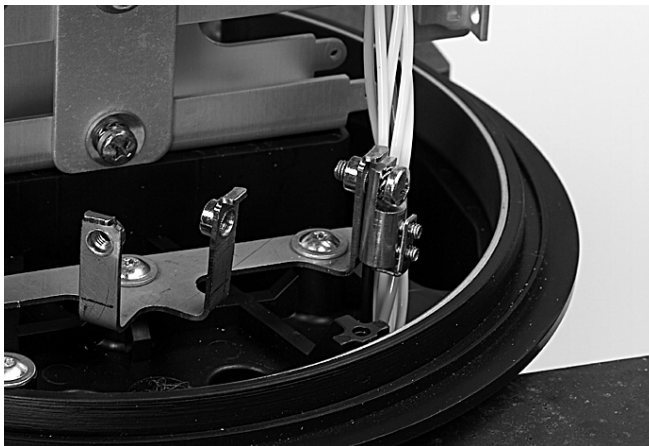

4.1.29 Secure the strength member.

#### 4.1g Tube preparation



4.1.30 Match the loose tube on the tubeholder, mark and strip the loose tube from this mark. Clean the fibers.

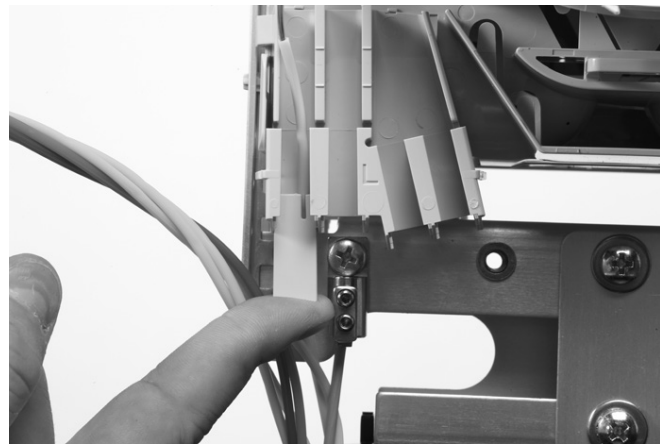

4.1.31 Position one or more loose tubes in the tubeholder according to the correct position and slide the tube holder retainer with the snap forward in the lowest possible cavity of the tubeholder above the loose tube. The tube holder retainer must snap. (see capacity of tubeholders).

#### 4.2 Central Core cable (Single Fiber), ribbon and compact sheet cable

##### 4.2a Looped cable preparation

4.2.1 **Twisted fibers: fibers have to be routed over the BASKET** : a window cut of **5m30** is needed for GCO2-BC6-XX, **5m90** for GCO2-BD6-XX and **6m10** for GCO2-BE6-XX. Mark the cable in the middle, and mark the cable (**2.65**), (**2.95**) or (**3.05**) meters left and right of the first mark. Remove the cable jacket and the strength members starting in the middle. For non cut loop storage contact CommScope to check if possible

**Twistfree fibers or limited twist: direct to tubeholder;** a window cut of **3m50** is needed for GCO2-BC6-XX, **3m70** for GCO2-BD6-XX and **3m90** for GCO2-BE6-XX. Mark the cable in the middle, and mark the cable (**1.75**), (**1.85**) or (**1.95**) meters left and right of the first mark. Remove the cable jacket and the strength members starting in the middle.

4.2.2 Mass storage facility: mount the basket (see Basket instruction).



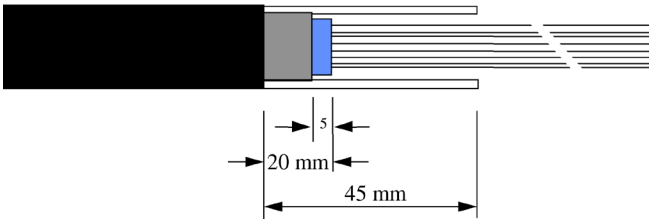

4.2.3 Remove the jacket for 45 mm leaving the strength members. Be careful not to damage the strength members.

4.2.4 Remove the central core leaving 20 mm from the cable jacket. Be careful not to lose fiber ID. In case of metal shield, remove 5 mm from the end.

4.2.5 Clean the fibers.

#### 4.2b Bracket/ Strength member and cable termination preparation

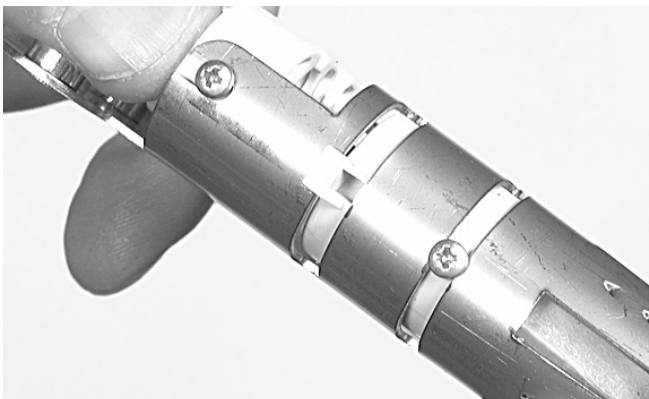
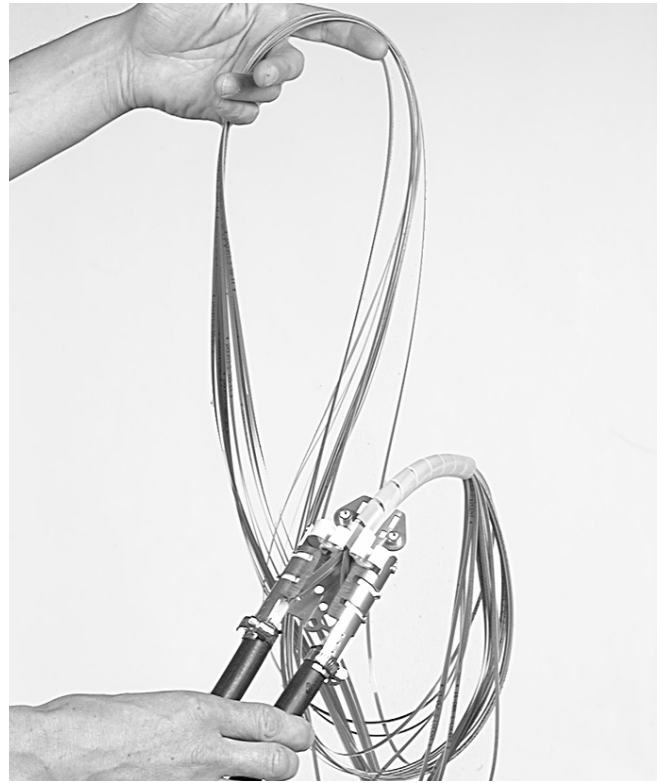

4.2.6 Slightly loosen the screws of the two strength member stops on the loopbracket such that one can position the strength member stops according to the position of the strength members.

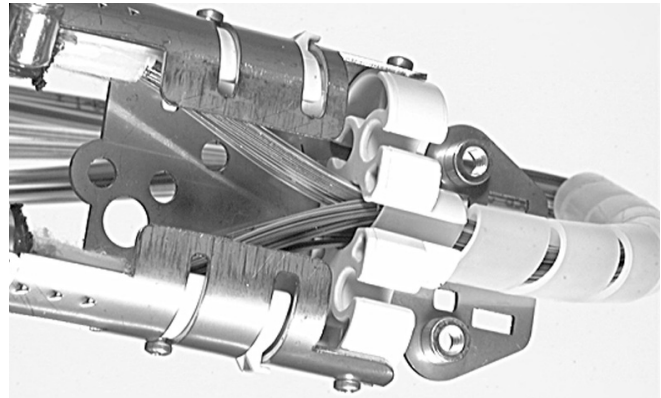

4.2.8 Take the spiral tube and cut at the length of **160 mm**. Put the tube over the bundle fibers and insert this in the central cavity of the loop breakout device.



4.2.7 Insert the strength members from the cable into the strength member stop. Secure the cable with the hose clamp onto the loopbracket. Secure the cable with tie wrap onto the loopbracket. Secure the screw of the strength member stop on the loopbracket. Wrap a few layers of tape around the hose clamp.

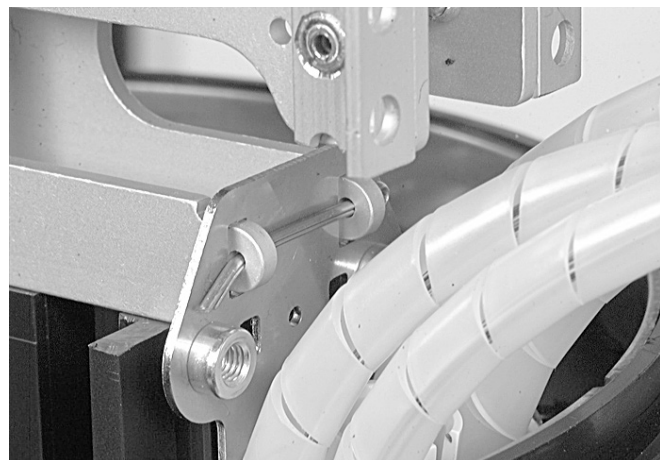

4.2.9 Position the loopbracket in the bottom bracket and lock with the split pin.

**4.2c Mass storage facility and twisted fibers: using basket (single fiber, ribbon and compact cable sheet)**

4.2.10 Start with mounting the basket.

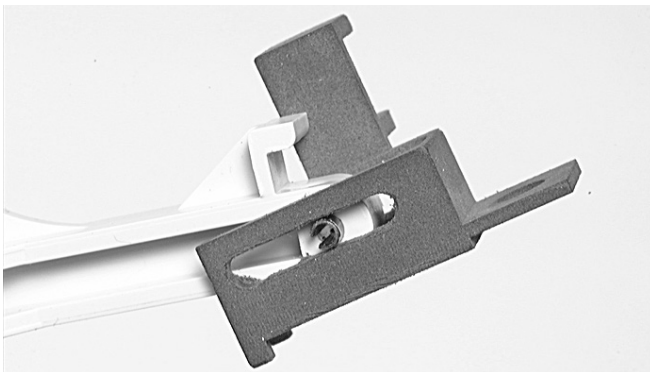

4.2.11 Install hinge on basket with pen.

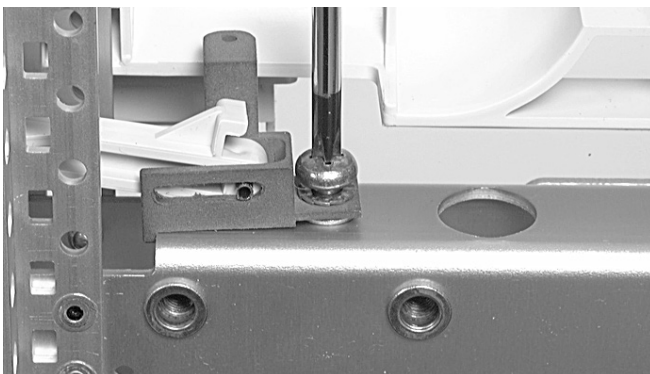

4.2.12 Mount hinge on GCO2.

4.2.13 Remove the cover by pulling it at the top of the basket (via the opening). When the top of the cover clicks out of the snaps slide the cover upward in the basket till it releases.

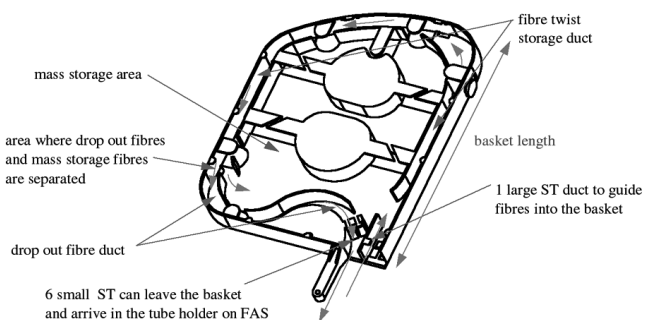

ST=Spiral tubing

4.2.14 A large spiral tube is wrapped around the twisted fiber bundle and secured in the loop bracket in the oval port. The length of the large spiral tube is given for each application: 16 cm for loopbracket cc. In the table below the capacities of this spiral tube are given.

Fiber type	Number of cut fibers/ribbons in spiral tube 15 OD	Numbers of looped fibers/ribbons in spiral tube 15 OS
SF	392+	196+
R12	36	18
R8	48	24
R4	100	50

4.2.15 This large spiral tube is placed in the right cavity of the basket by bending the spiral tube and gliding it in its cavity when the basket is in an almost closed position.

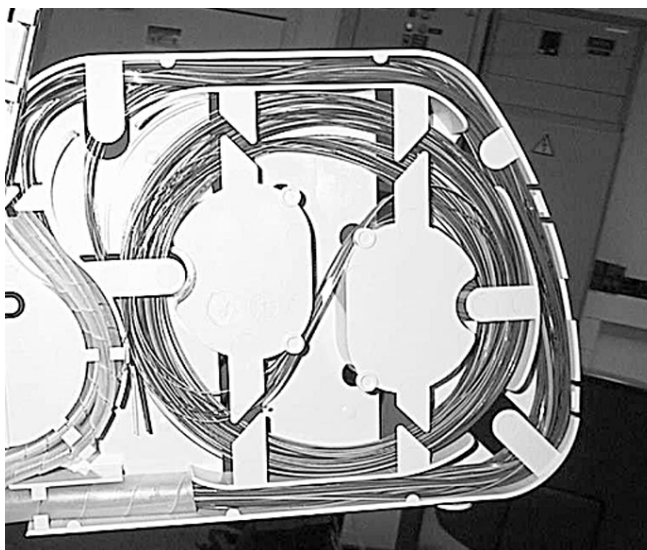

4.2.16 **All** fibers are placed in the "fiber twist storage duct" as shown on the figure above. **One has to place the fibers as far as possible at the outside of the path** because when closing the basket some overlength will be pulled out of the basket (risk of loading fibers when basket is hinged).

4.2.17 At the point of separation, mass storage fibers and fibers to drop out are separated. This is possible because all cable-twists are stored in the "fiber twist storage duct".

4.2.18 The fibers for mass storage are organized in the mass storage area of the basket, the loop end is placed over one of the islands.

4.2.19 The fibers that need to be guided to the routing block are wrapped with a small spiral tube with a length of 37 cm. Make sure you group the fibers/ribbon going to the OS1 or ES2-side of a closure separately. Place as many fibers as possible fibers together in one spiral tube to maintain a high drop out capacity of your basket (see table below). (The addition of fibers in an occupied spiral tube is not possible without removal of the spiral tube, causing transients in the optical fibers).

Fiber type	Number of cut fibers/ribbons in spiral tube 6 OD	Numbers of looped fibers/ribbons in spiral tube 6 OS
SF	70	35
R12	6	3
R8	9	4
R4	14	7

A maximum of 6 spiral tubes (6 mm OD) can be dropped from the basket.

4.2.20 Guide the spiral tube through the bottom bracket of the closure to the side of the FAS opposite to the hinge side of the basket to the tube holder (OS1 and/or ES2). To install the spiral tube in the tube holder place the spiral tube in the holder and mark the place where the tube holder retainer will be. The place is wrapped with a 3 cm long FOAM strip after the grease is removed from the location with an isopropylalcohol tissue. One has to make sure the foam strip is under the tube holder retainer by inserting tube and retainer in one go. After installation of the tube holder retainer the fibers can be placed in the organiser system.

4.2.21 Insert the fiber and the spiral tube in the "drop out fiber duct" (as shown in 4.2.19). Insert the spiral tube in the basket in the way it passes the top of the bend and end just before the fiber containment lip. Store the first three spiral tubes at the inside of the bend. The next three at the outside. To pass the fiber containment lip on top of the bend one can enlarge the space between both lips by bending the outer lip.

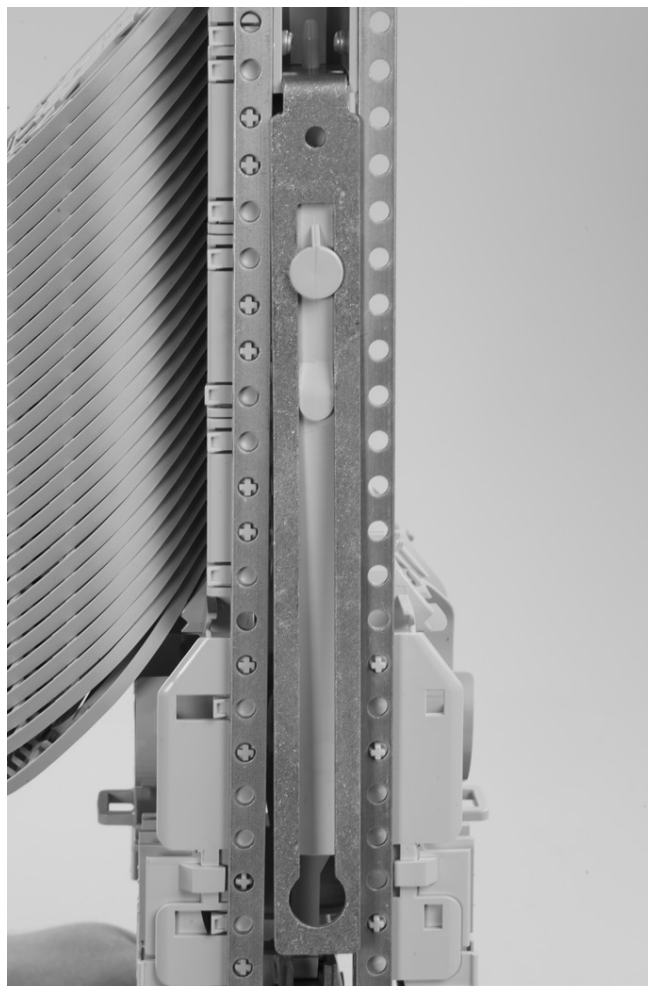

4.2.23 Secure the basket by mounting the metal profile on basket and closure bracket.

Remark: when the basket is closed, check if the large spiral tube is well placed in the loop breakout device.



4.2.22 Place cover back in place, Make sure the cover is under the lip of the bottom island. Hinge the basket inbetween the UMS profiles and make sure the hinge is in the correct position.

**4.2d Twistfree fibers or limited twist (single fiber, ribbon and compact cable sheet)**

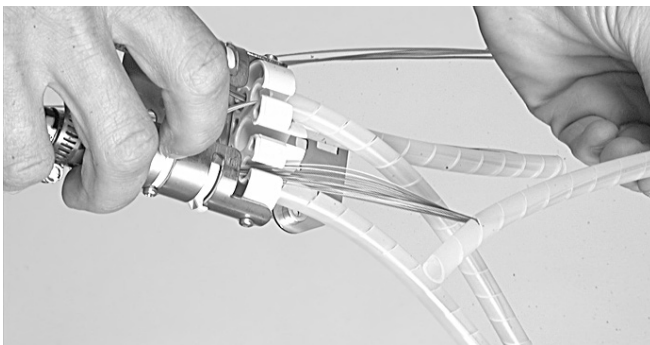
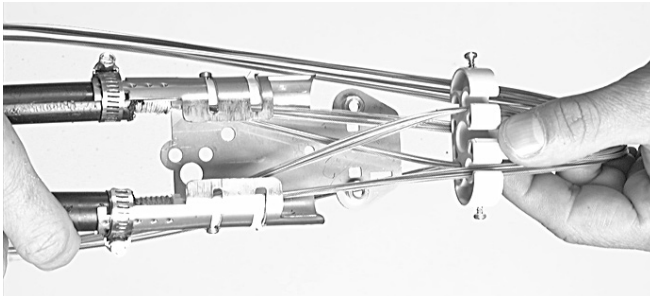
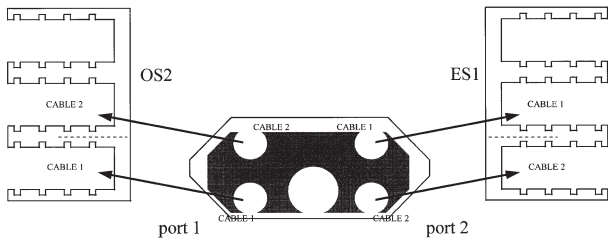

4.2.24 Divide the fibers according to the position in the loop breakout device (fig.); in the 4 small cavities and spiral tubes (ST) directly to the trays in a way that fibers going to the O-side and E-side of the closure (also marked on the loop breakout device) are divided, divide also the exchange and customer fibers (avoid unnecessary crossings). Typical a looped fiber will be put in two spiral tubes going to the same side of the closure (O- or E-side). Put the spiral tubes over the different bundles of fibers and insert afterwards the spiral tube with fibers in the loop breakout device.

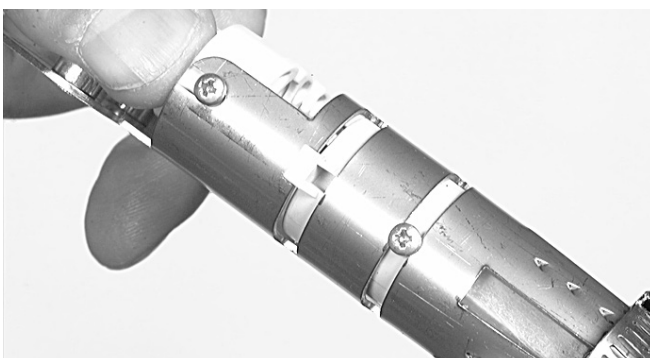

4.2.25 Slide the loop breakout device in the loopbracket and secure the two screws. Open the oval port as described in loose tube preparation. Take the oval sleeve and place the packing bag that has been opened on both sides in the oval sleeve to protect the hotmelt inside the sleeve against dirt and grease. as described in loose tube preparation.

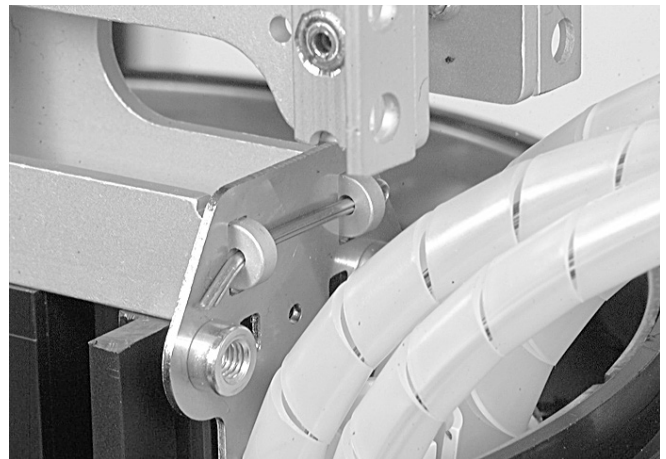

4.2.26 Push the fibers in the oval port and position the loopbracket in the bottom bracket and lock with the split pin.

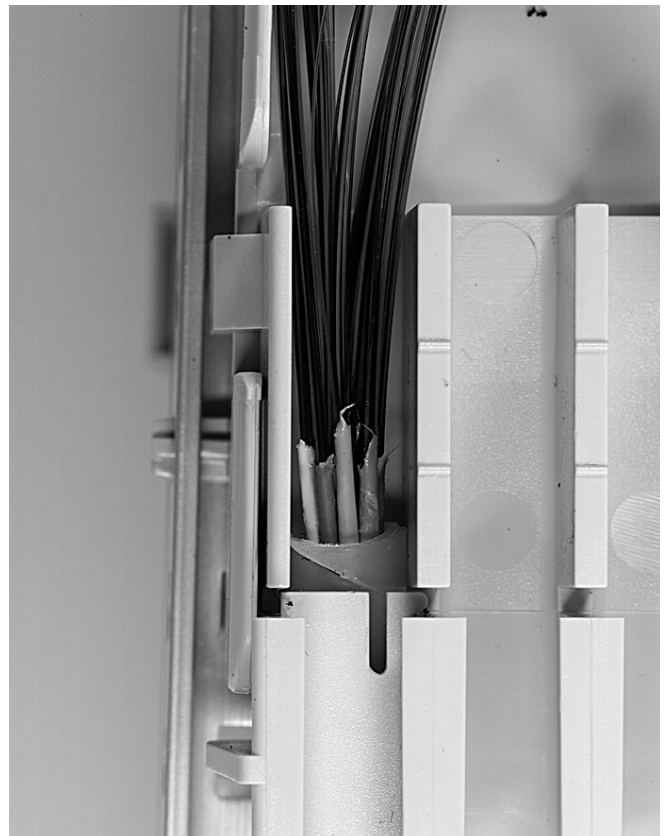

4.2.27 Match the spiral tube on the tubeholder, mark and cut the spiral tube from this mark. Remove element per element the ID cords or compact cable sheet (Microgain™, Compacttube™, ...) till about 10 mm after the spiral tubes; use PTFE tape to bundle the fibers and the ID cord. Position the small spiral tubes in the respective tubeholders. Bottom picture shows compact cable sheet.

## 4.2e Drop cable preparation (6 port base)

4.2.28 Remove the cable jacket 2.2m.

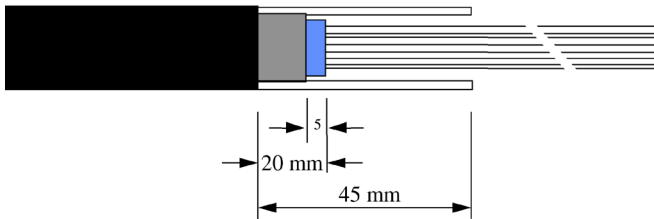

4.2.29 Remove the jacket for **45 mm** leaving the strength members. Be cautious not to damage the strength members. In case of metal shield, remove 5 mm from the end.

4.2.30 Remove the central core leaving **20 mm** from the cable jacket. Be careful not to loose the ID of the fibers.

4.2.31 Clean the fibers.



4.2.32 Loosen a little bit the screws such that one can position the strength members stop according to the position of the strength members and remove the break-out part.

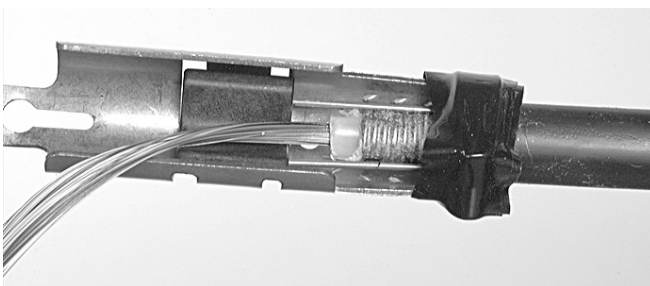

4.2.33 Insert the strength members from the cable into the strength member stop. Secure the cable with the hose clamp in case cable diameter is more than 8 mm. onto the bracket. Secure the cable with tie wrap in case cable diameter is less than 8 mm. onto the bracket. Secure the screw of the strength member stop on the bracket. Wind a few layers of tape around the hose clamp.



4.2.34 Put the fibers in the breakout through the center (put the tube stop at cable jacket side) and slide the breakout on the bracket and secure it with the screw.

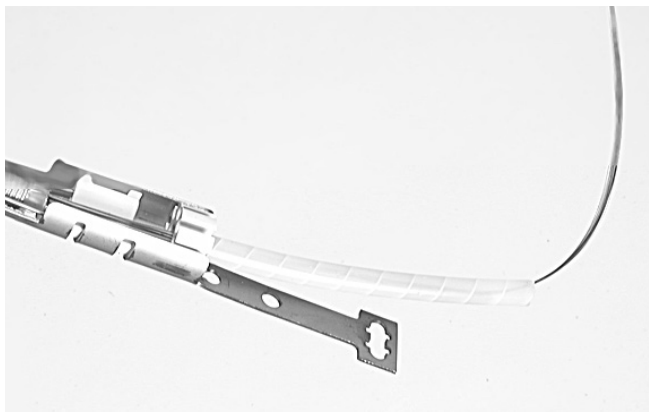

4.2.35 Insert the spiral tube over the fibers into the breakout till the tube stop. Open the round port and place the heatshrink as discribed in loose tube preparation.



4.2.36 Secure the round port cable fixation bracket (using a Phillips screwdriver) on the bottom bracket.

**4.2.f Drop cable preparation (16 port base)**

4.2.37 Remove the cable jacket for 2.2m.

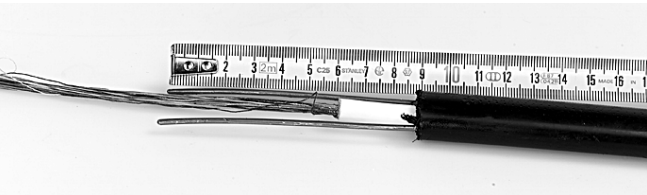

4.2.38 If big ports 3-4-5-6-7-8-9-10 are used, cut strength member to 90 mm length.  
If small ports 11-12-13-14-15-16-17-18 are used cut strength member to 75 mm length and cut the central core at 30 mm from the jacket.

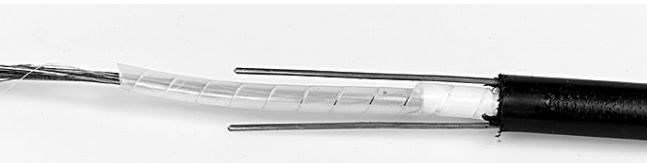

4.2.39 Put the spiral tube on the cable

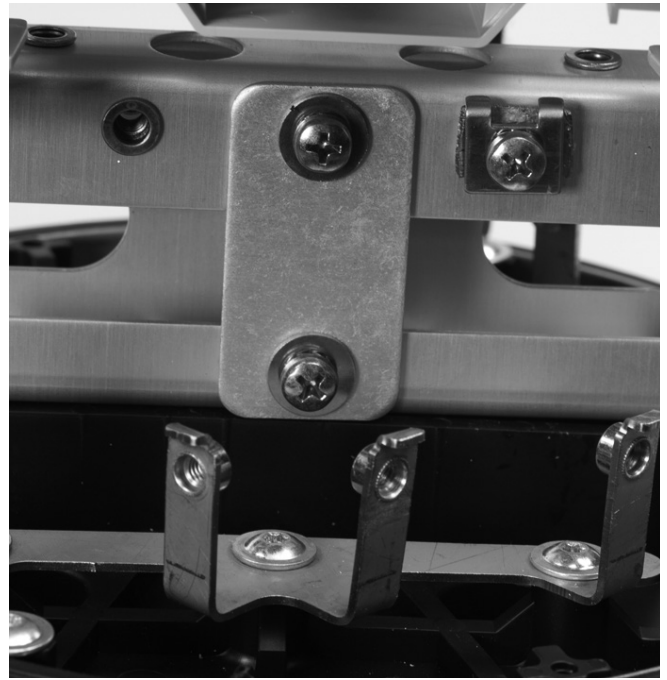

4.2.40 Secure the strength member plates in the closure. Use FACC-DSCT for dual strength member cables.



4.2.41 Secure the strengt member.

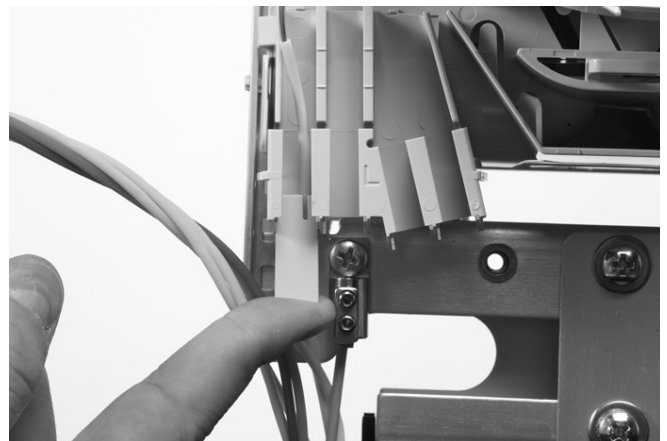

4.2.42 Remove the ID cords or compact sheet till about 10 mm after the spiral tube; use PTFE tape to bundle the fibers and the ID cord. Position the spiral tubes in the respective tubeholder. Put the tube holder retainer.

## 5 Installation of the heatshrink

### 5.1 Oval port



5.1.2 Clean and abrade the cable.

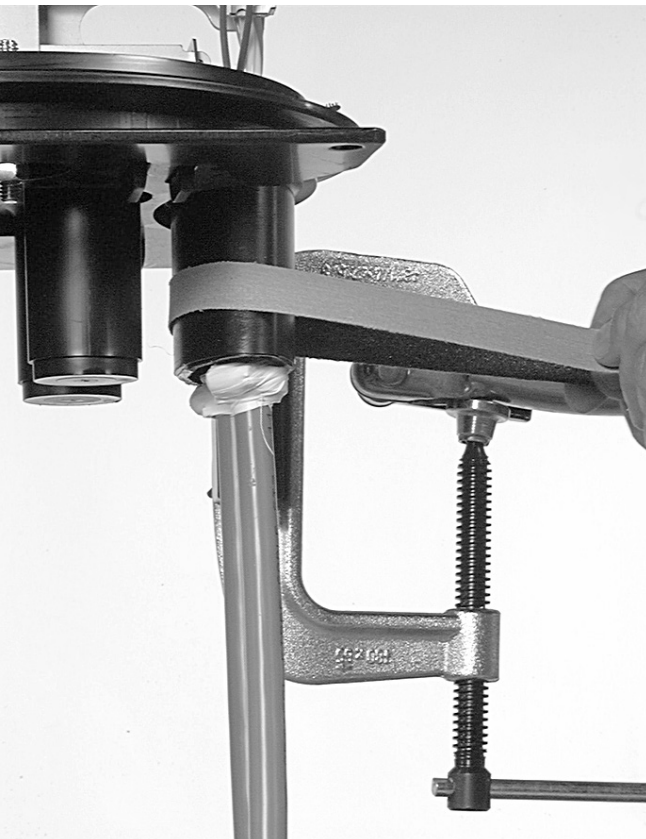

5.1.1 Clean by using the cleaning tissue. Abrade the port.



5.1.3 Remove the packing bag out of the sleeve, push the sleeve upwards to the base and mark the cable flush with the sleeve. Make sure the non-coated zone butts up against the base.



5.1.4 Match the blue line of the aluminium protection foil with the marks on the cables. Wrap aluminium cable protection foil around the cable (the aluminium foil should not be more than 30 mm inside the sleeve).

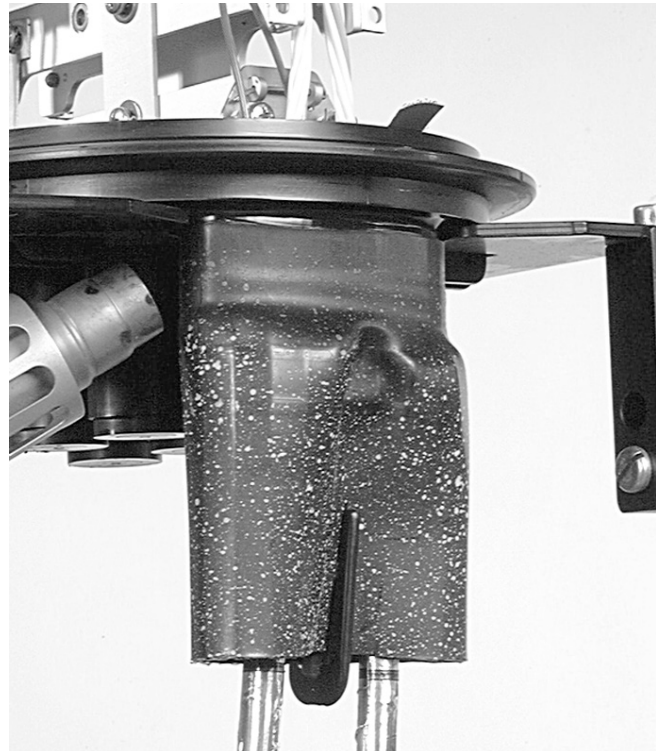

5.1.6 Start heating the seal on the base, and wait one minute and shrink in spiral movements downwards.



5.1.5 Push the sleeve against the base and place the clip.

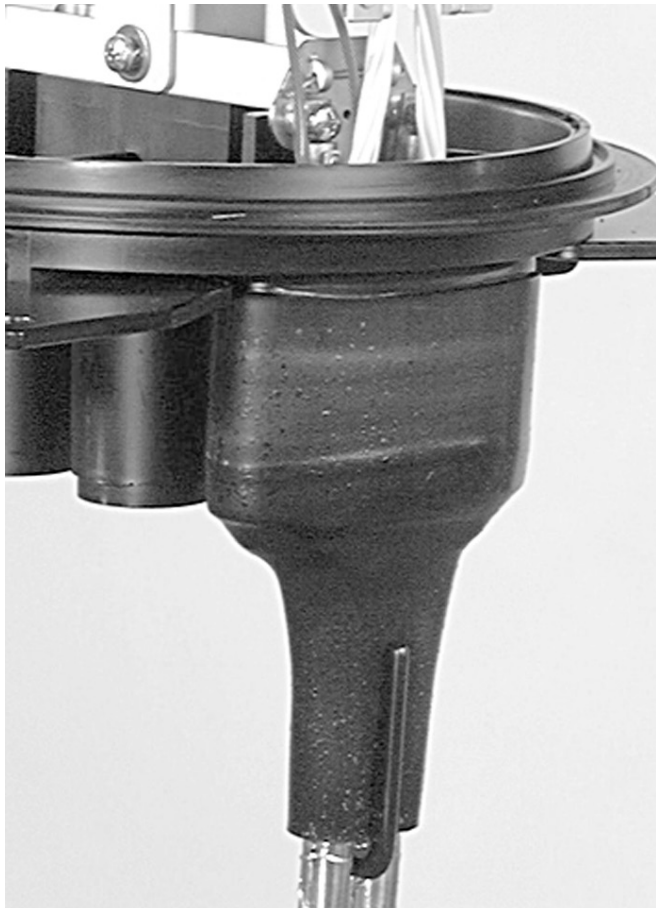

5.1.7 Hold the cable in position. Shrink till the green painting dots become black, and the hotmelt is visible on the end of the sleeve. Postheat the clip on both sides till the adhesive shows a proper flow on the clip between the two cables.

**Do not move the FIST-GCO2 or cable during 20 minutes.**



## 5.2 Round port

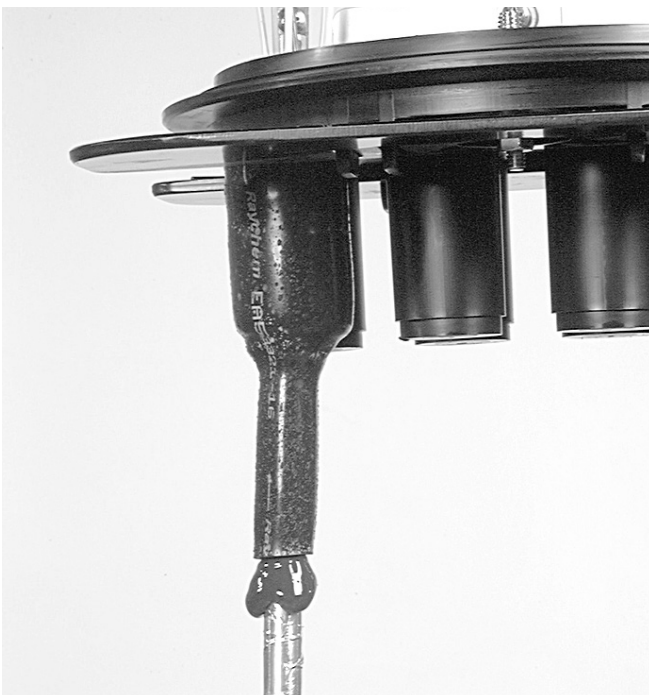
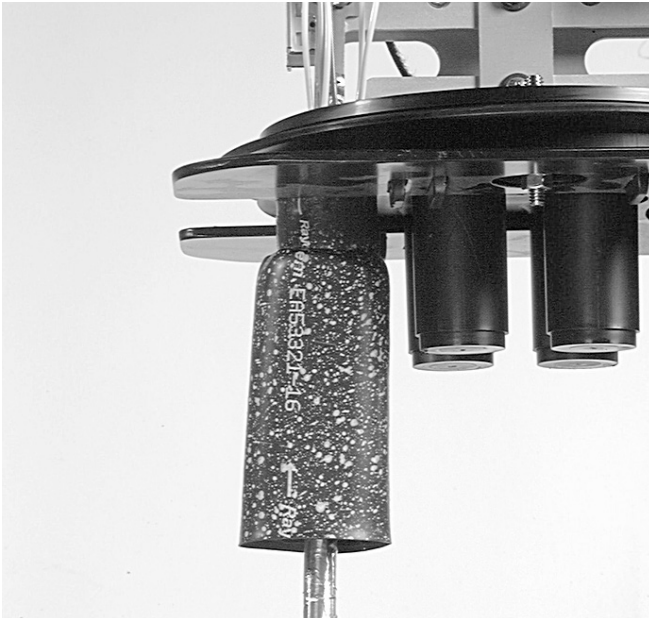

5.2.1 Repeat all the steps as described in oval port.

## 5.3 6 port base

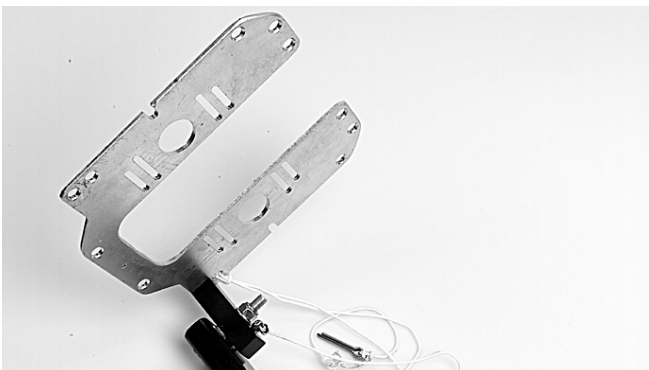

5.3.1 It is recommended to use the hinged workstand.  
**Note:** use the appropriate seals for the ports.

## 6 Fiber routing

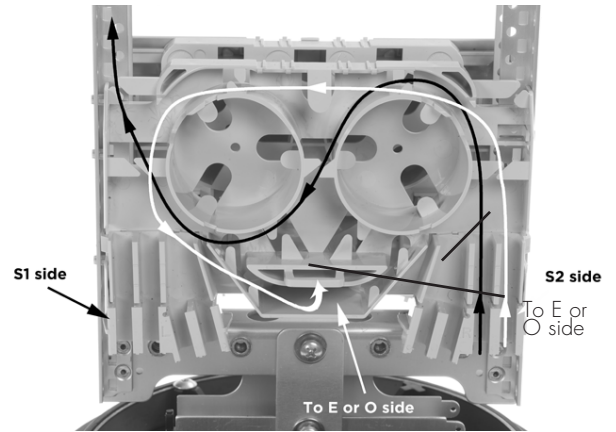

Fibers can be routed between OS1, OS2, ES1 and ES2. In case that fibers have to be routed from SIDE-O (Odd portnumbers) to SIDE-E (Even portnumbers), use the window (see picture). Select the cable termination as such, that a minimum of fibers will cross and have to be routed through the window. Therefore the selection of the ports according to the cable lay-out is important.

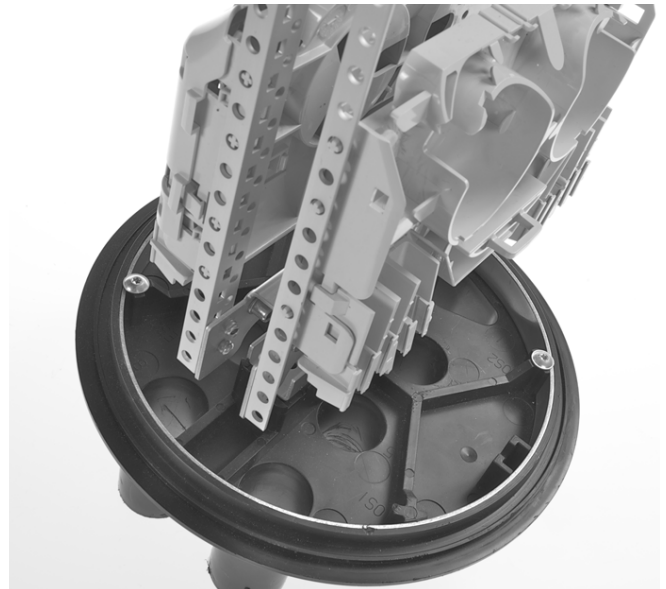

**6 PORT BASE:** Ports (1+3), (6+8) for cables to (S2). Ports (5+7), (2+4) for cables to (S1). Verify the position of two cables if they are placed on the same side (next to each other) because the total amount of loose tubes in ports (1+3) or (2+4) or (5+7) or (6+8) can never be more than mentioned in the capacity of the tube holder.

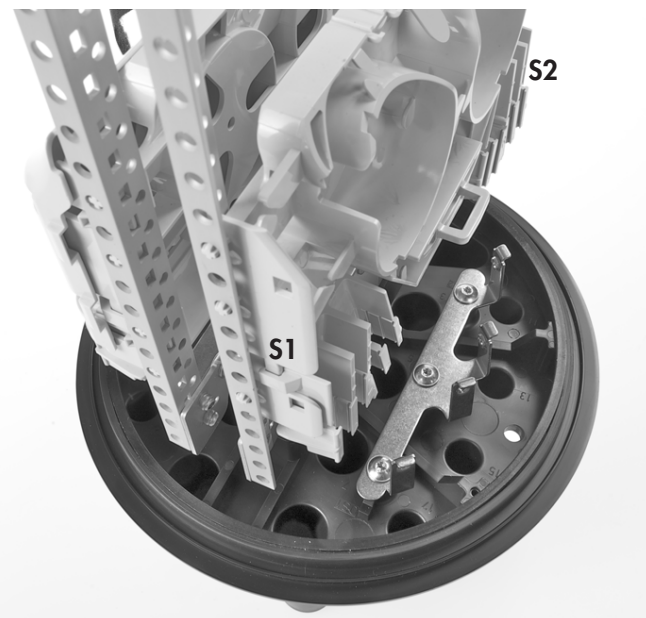

**16 PORT BASE:** Ports (1+3+5+11+13), (2+4+6+12+14) for cables to (S2). Ports (5+7+9+15+17), (6+8+10+16+18) for cables to (S1). Verify the position of two cables if they are placed on the same side (next to each other) because the total amount of loose tubes in ports going to one tubeholder can never be more than mentioned in the capacity of the tubeholder.

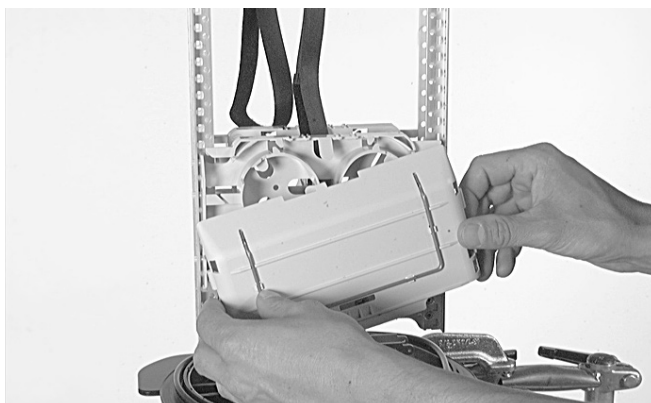

6.1 Remove the hook and loop fastener and routing block cap. To remove the routing block cap lift the two snaps at one side of the routing block cap.

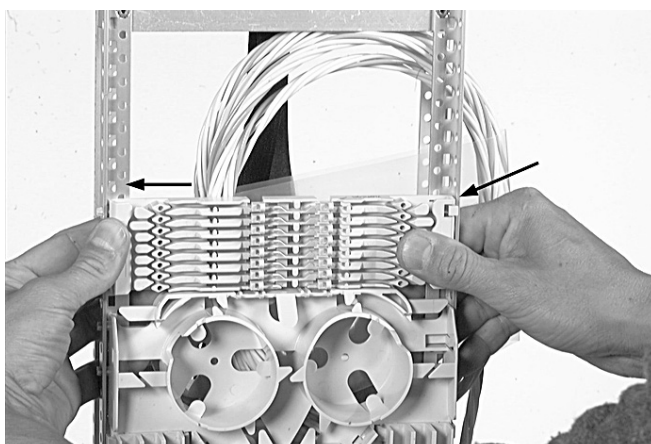

6.2 Secure the wraparound groove plate on the UMS by putting the plate with the long protrusions in the S1 UMS-profile and sliding the plate in the S2 UMS-profile until it snaps. (Do not leave gaps between groove plates).

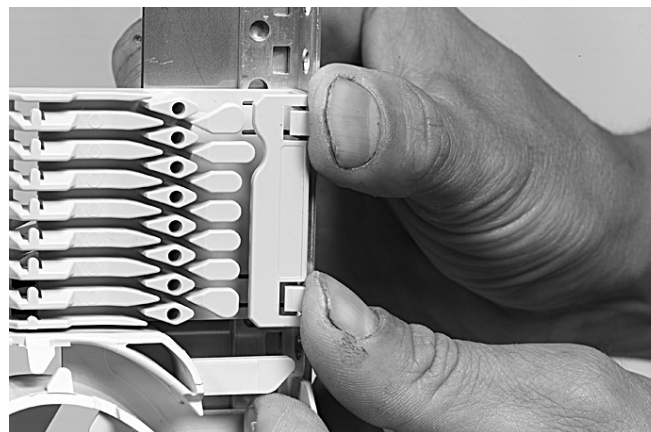

6.3 To remove push the two snapfits at S2 UMS-profile and slide the wraparound plate towards S1 UMS-profile.

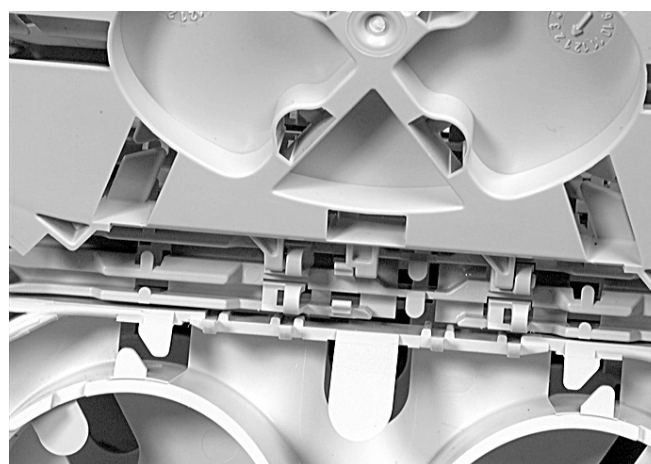
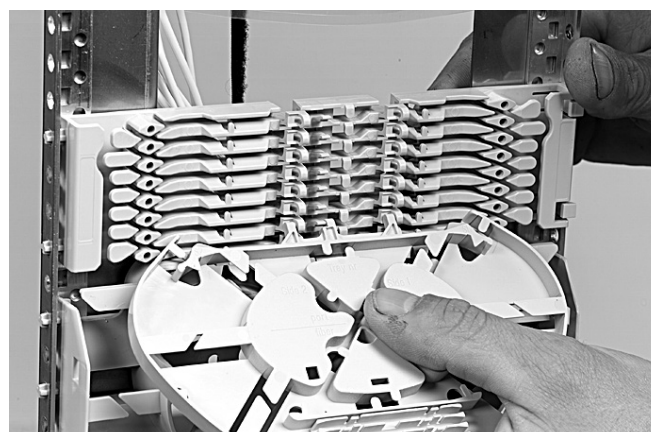

6.4 Place a tray in the wraparound groove plate, push the lip on the groove plate (lowest possible position) slightly down with the tray and move the tray lateral into the hinge-cavities of the groove plate. To snap the single element tray (SE) in the wrap around single fiber groove plate **leave always one hinge facility open between FAS block or previous tray and the SE-tray.**



6.5 To remove the tray put the fiber guiding pin between lip on wraparound groove plate and tray and move lateral towards S1.

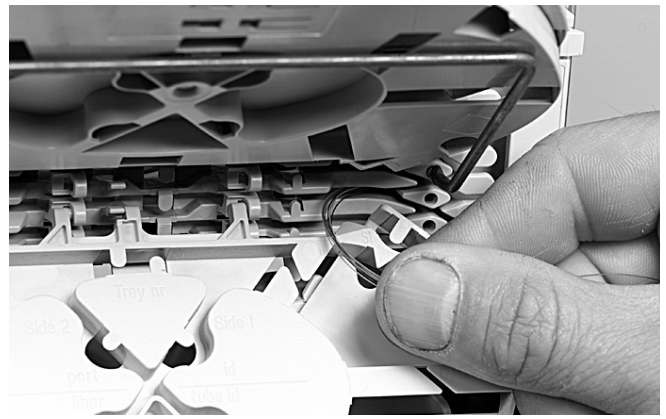

6.7 Route the fiber in the grooves of the wraparound groove plates to the entrance of the appropriate tray. Fiber must be routed in the groove below the hinge of the tray!

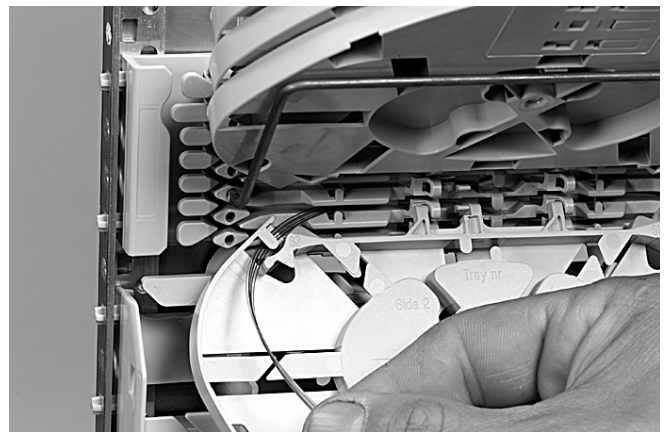
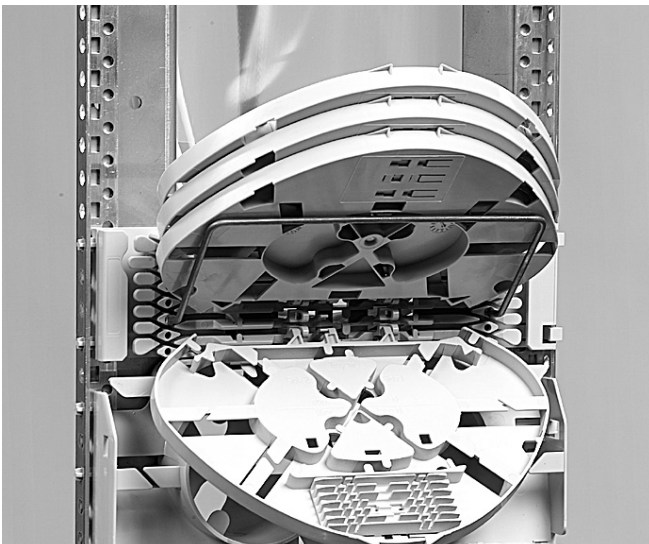
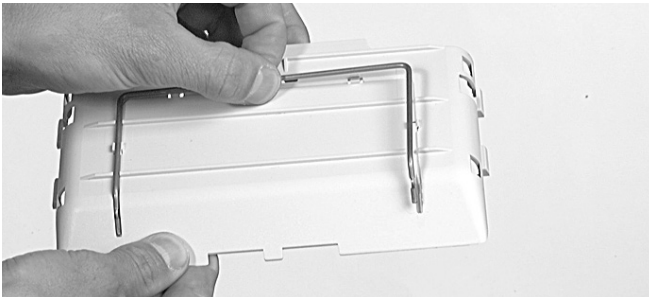

6.8 Pull gently on the fibers in the tray and make sure that the fibers are well contained in the routing block and wraparound groove plate.

6.6 Identify the tray to be worked on and make it accessible. If the routing block and trays are in vertical position you will have to support the trays above the selected one using the tray wedge which fits in the cavities of the wraparound groove plate. Position the wedge carefully such that the groove is still accessible for the fibers and be careful not to push the wedge against fibers. To remove the wedge, use two hands to pull on both ends (near the groove plate).

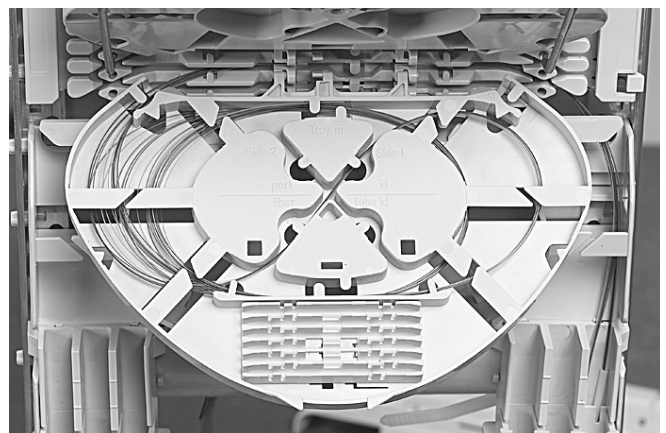

6.9 Store the fibers temporarily on a tray (picture shows the case of a loopback).

6.10 Storing dark fibers can be done in different ways.

- 1) Organise dark fibers into the different trays, following instructions as described.
- 2) Organise dark fibers together into the first available tray (i.e. with a max. of 24 cut or 12 loops primary coated fibers in one SE-tray).

## 7 Fiber routing on tray

7.1 Take the splice protector and put it centred towards the splice holder

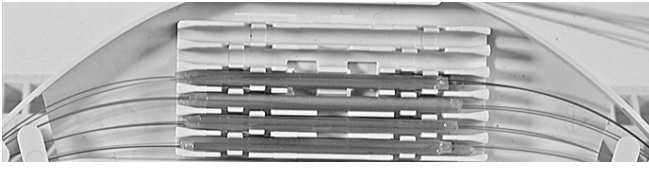

7.2 SMOUV in SE tray.

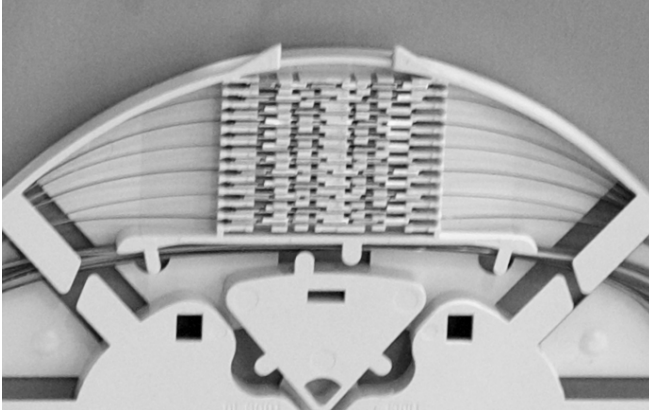

7.3 ANT in SE tray.



7.4 RECORDsplice in SC tray.

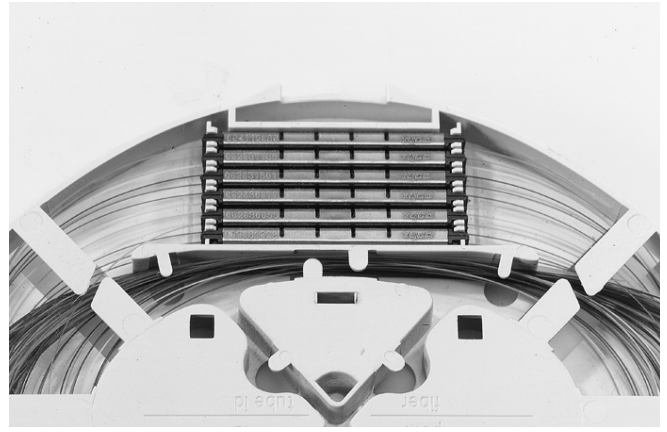

7.5 RECORDsplice in SE tray.



7.6 RECORDsplice/ANT in SC tray.



7.7 Ribbon 4/8 tray.

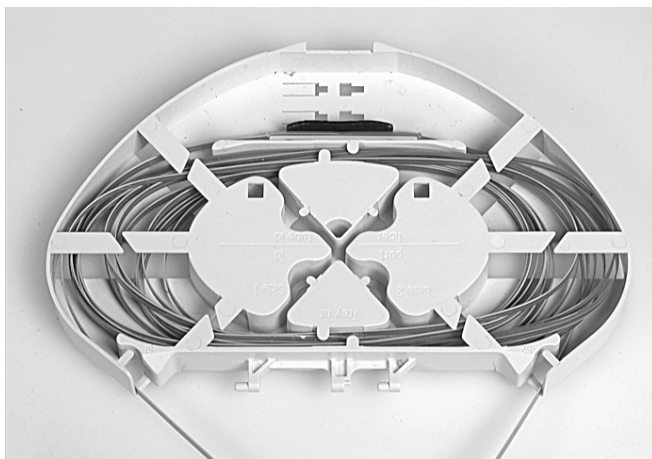

7.8 Ribbon 12 tray.

## 8 Tube holder capacity and tray identification Number x outer diameter loose tube (mm)

### Overview loose tubes

LOOSE TUBE 1,5 mm (3 retainers)  
4x30 = 120 tubes

LOOSE TUBE 2,3 mm (3 retainers)  
4x12 = 48 tubes

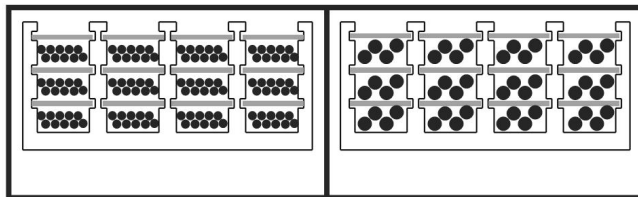

### Overview FOPT tubes

FOPT TUBE 1,8 mm (3 retainers)  
4x30 = 120 tubes

FOPT TUBE 3,1 mm (3 retainers)  
4x9 = 36 tubes

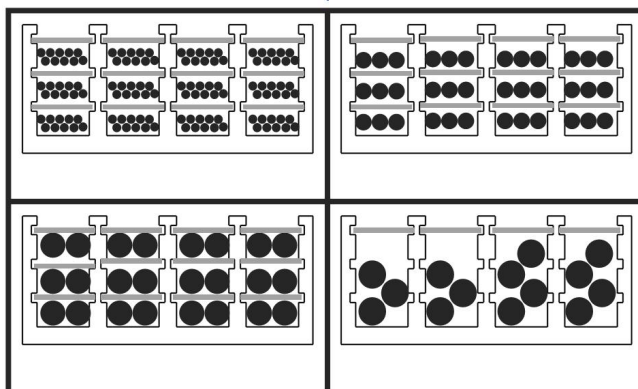

FOPT TUBE 4,3 mm (1 retainer)  
4x6 = 24 tubes

FOPT TUBE 5,0 mm (1 retainers)  
(2x3) + (2x4) = 14 tubes

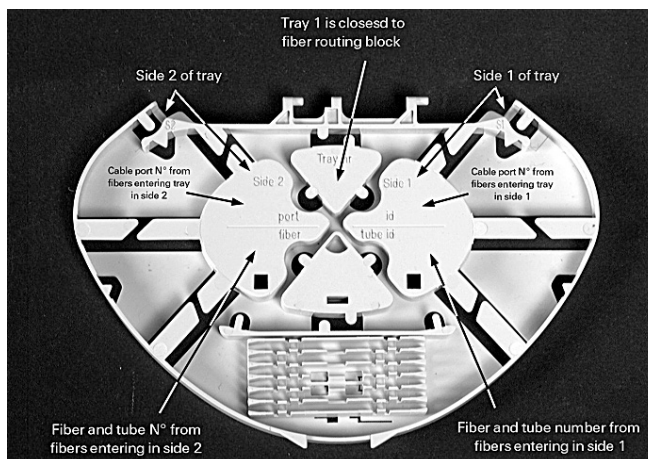

8.1 Use a permanent marker to write on the tray.

## 9 Cable grounding

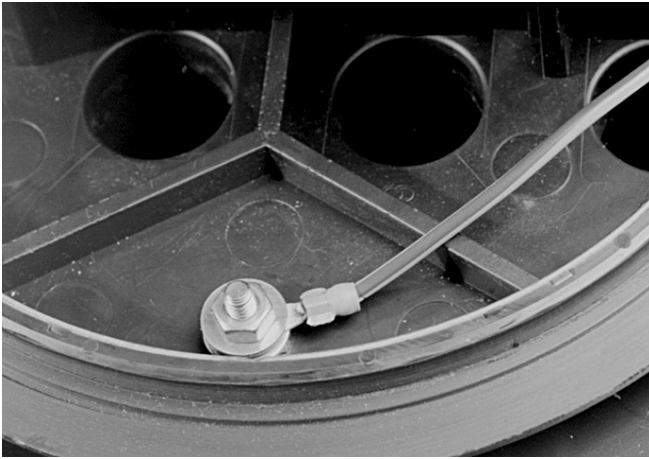

9.1 In case of grounding, mount grounding wire on the grounding bolt

## 10 Closing the closure

10.1 Remove the outer bag and place the Silica gel in the closure (be careful, do not disturb any fiber or tube routing)

10.2 Place the o-ring back on a clean base and place the dome on top of it.

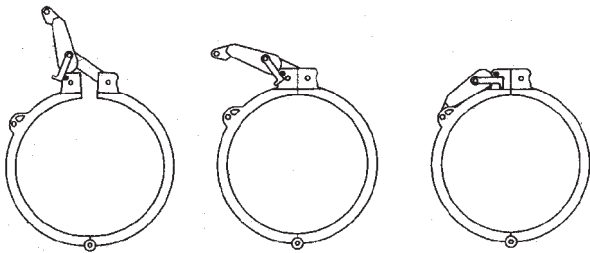

10.3 Close with clamp.

## 11 Important steps during installations

- Make sure that grooves on the wraparound groove plate are clean.
- Clean the fibers.
- Be sure that fibers are not stored too tight in the trays, to prevent stress on the fibers.
- Loose tubes routed up to the tube holder should be routed in such a way that one still has complete access of the stored tubes between UMS profile. This is needed for later routing of loose tubes from the loops to the tube holders without creating crossings and without creating disturbances on the loose tubes already routed up to the tube holders.
- Use correct lengths in the tubeholder.
- Make sure not to lose ID.
- Be secure when preparing window cut on loose tube cable for storing uncut fibers.
- Avoid in all cases crossings of fibers and loose tubes in the cable brackets.
- When using cables with a diameter smaller than 12 mm in a cable bracket, bend the sharp edges towards the cable and use some tape around the bracket to protect the heatshrink.
- Replace the Silica gel each time the closure has been opened.
- Do not place the aluminum protection foil too deep in the heatshrink.

## 12 Re-arrangement

Avoid to pull fibers in between groove plates.

Avoid fiber movement between tubeholder and first containment lip on the routing block.

Take special care rearranging fibers from E to O side or reverse.

If accidentally active fibers are removed from the containment devices, reposition them carefully.



